

St Hilda's Primary School
Primary 5
Science
Term 3 Weighted Assessment, 2025

Section A	24
Section B	11
Total Score	35

Name: _____ ()

Class: P5 / _____

Duration: 45 minutes

Total no. of pages: 15

Date: _____

Section A: 24 Marks

Parent's Signature: _____

For questions 1 to 12, write your answer (1, 2, 3 or 4) in the bracket provided.

[2 marks each]

1 The diagram below shows the tiny openings found on a leaf.

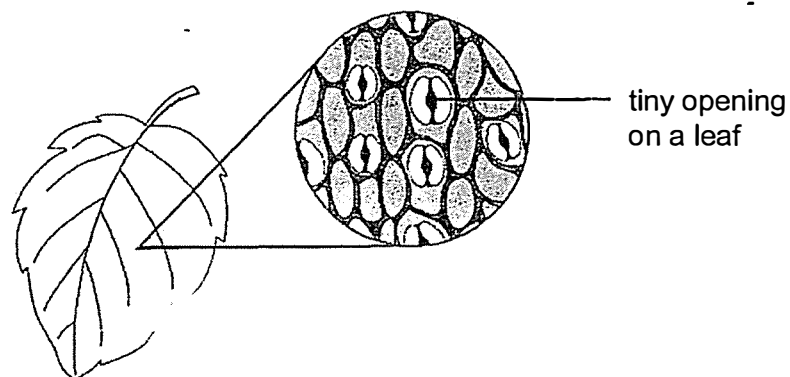

Which of the following statements is correct?

- (1) The tiny openings make food for the plant.
- (2) The tiny openings allow the exchange of gases.
- (3) The tiny openings trap light for plant to make food.
- (4) The tiny openings take in water from the surrounding.

()

SCORE	2
-------	---

- 2 Minah drew a diagram with arrows A, B, C and D, to show the movement of food and water in a plant.

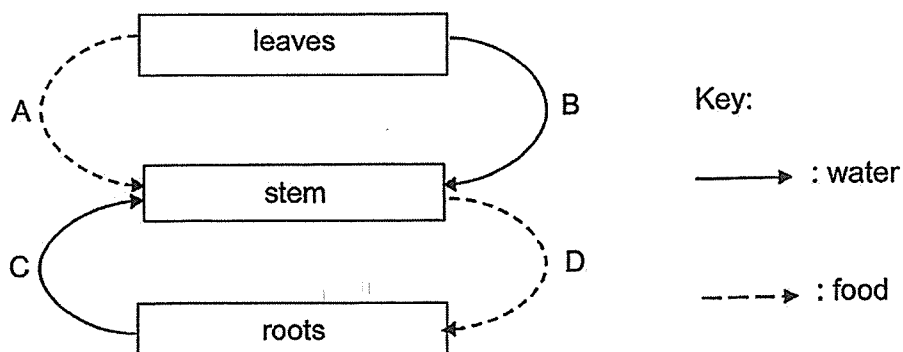

Which one of the arrows is not correct?

- (1) A
- (2) B
- (3) C
- (4) D

()

SCORE	2
-------	---

3 The diagram below shows parts W, X, Y and Z of a flowering plant.

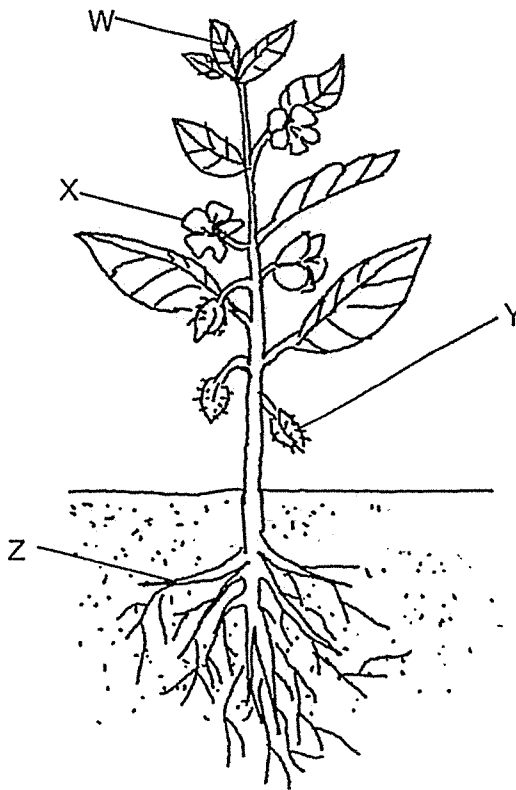

In which parts of the plant can both the food-carrying tubes and water-carrying tubes be found?

- (1) W only
- (2) Y and Z only
- (3) W and Z only
- (4) W, X, Y and Z

()

SCORE	2
-------	---

- 4 Lisa observed flower A growing on a plant. She removed the food-carrying tubes at position X and Y as shown below.

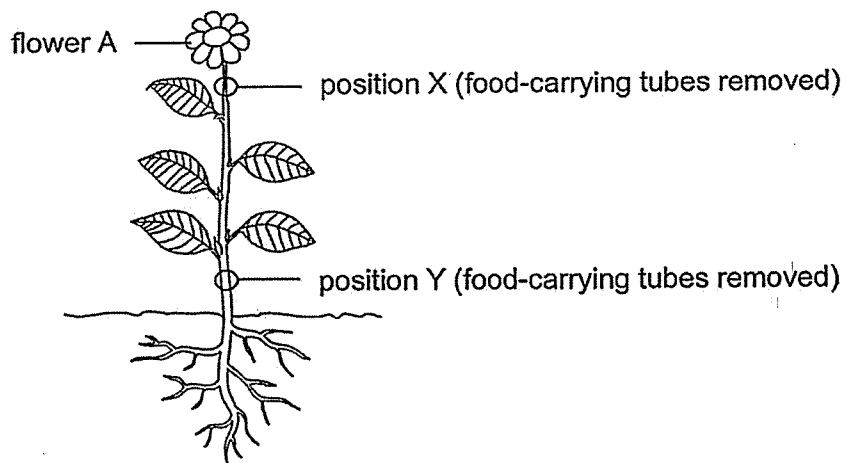

After a week, she observed that flower A had wilted and died while the leaves continued to grow healthily.

Which of the following statements best explains her observations?

- (1) The roots cannot absorb water for the flower.
- (2) The flower died as it cannot receive water from the roots.
- (3) The flower died as it cannot receive food from the leaves.
- (4) The leaves cannot receive water from the roots so the leaves cannot make food for the flower.

()

SCORE	2
-------	---

- 5 William carried out an experiment using the set-up below. He cut the stem of a celery into two parts and placed each part into a container of red-coloured water and a container of blue-coloured water.

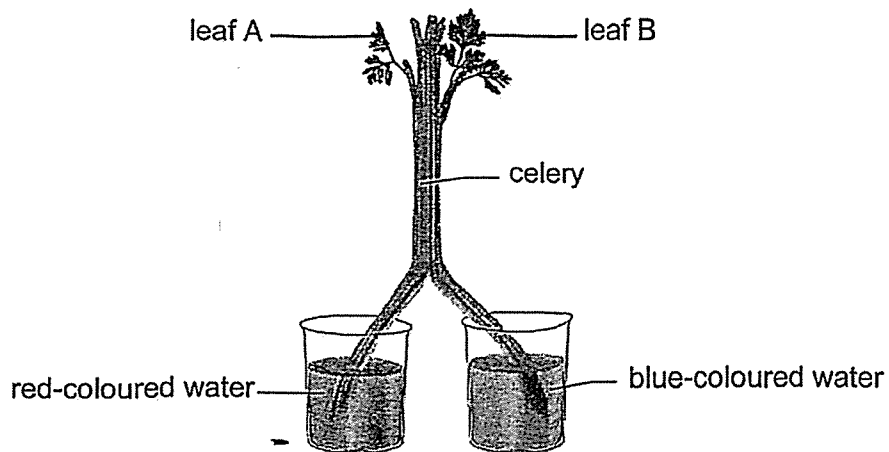

Which of the following observations about the set-up is likely to be true after three days?

- (1) Leaves A and B remained green.
- (2) Leaves A and B turned reddish blue.
- (3) Leaf A turned red while leaf B turned blue.
- (4) Leaf A turned blue while leaf B turned red.

()

SCORE	2
-------	---

6 The diagram shows an adult flowering plant.

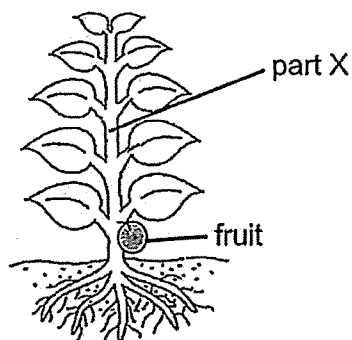

Which row shows the correct direction in which food and water are being transported at part X of the plant?

Direction for transport of		
	food	water
(1)	upwards	upwards
(2)	upwards and downwards	downwards
(3)	downwards	downwards
(4)	upwards and downwards	upwards

()

7 Peter set up an electrical circuit as shown in the diagram below. However, the bulb remained unlit.

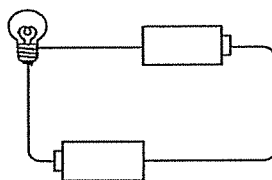

Which of the following could be the possible reason?

- (1) The bulb had fused.
- (2) The wires were made of copper.
- (3) There was no switch in the circuit.
- (4) The batteries were arranged wrongly.

()

SCORE	4
-------	---

8 The diagram below shows a torch in working condition.

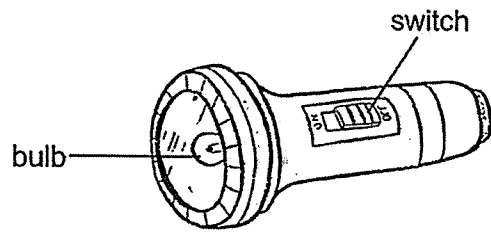

Which diagram shows the correct circuit for the torch?

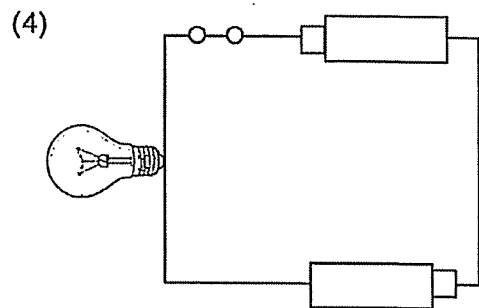
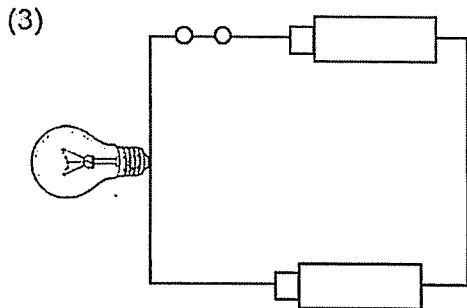
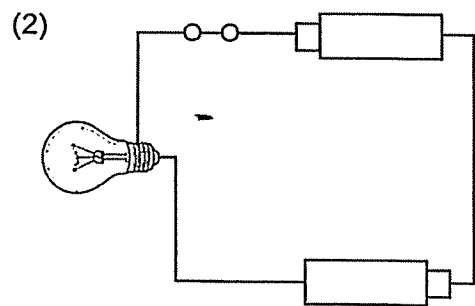
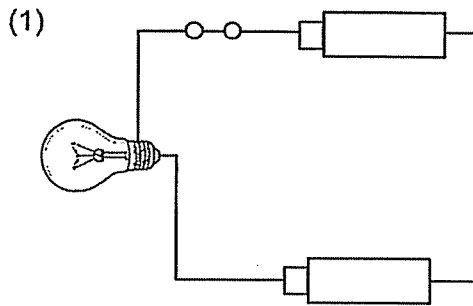

()

SCORE	2
-------	---

- 9 Gayathri set up four different circuits as shown below using identical batteries and bulbs, J, K, L and M. All electrical components are in working condition.

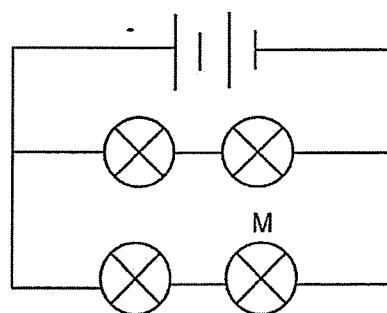
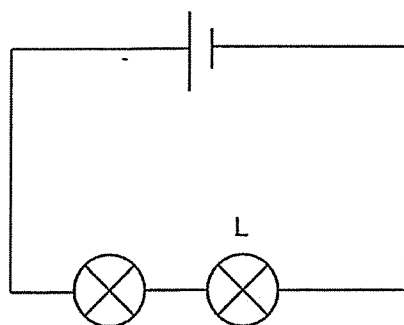
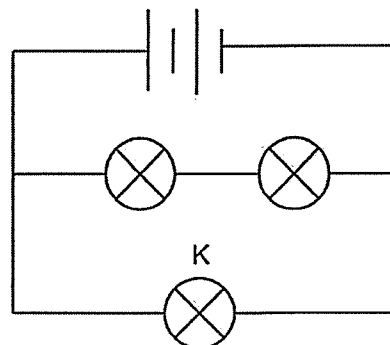
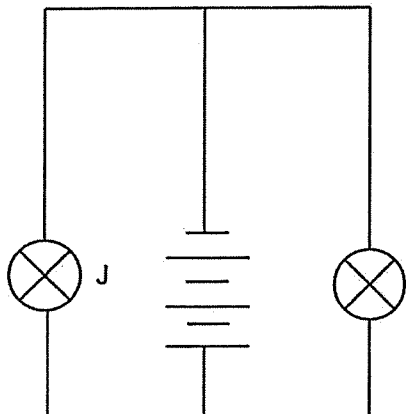

Which of the following shows the correct arrangement of the brightness of the bulbs starting with the dimmest bulb to the brightest bulb?

	Dimmest bulb	→	Brightest bulb
(1)	K , L , J		M
(2)	K		L M J
(3)	L , K		M J
(4)	L , M , K		J

()

SCORE	2
-------	---

- 10 Matthew made a circuit tester and a circuit card consisting of four steel paper clips, A, B, C and D. Some of the paper clips are connected by wires.

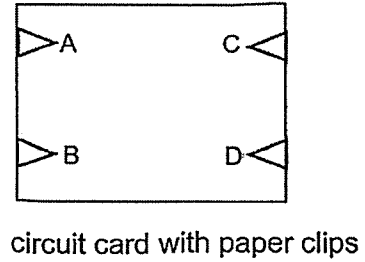
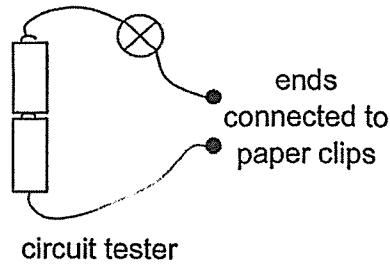

The two ends of the circuit tester were connected to two different paper clips at a time. He recorded his observations in the table below.

Paper clips connected	Did the bulb light up?
A and D	Yes
A and B	Yes
B and D	Yes
C and D	No

The diagram below shows four possible ways the wires at the back of the circuit card, P, Q, R and S can be connected to the paper clips.

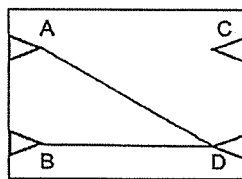

Card P

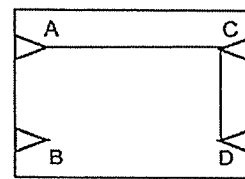

Card Q

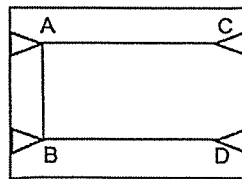

Card R

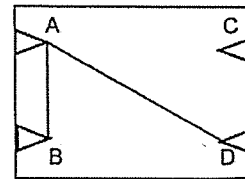

Card S

Which of the following show the circuit cards with the correct connections?

- (1) P and Q only
- (2) P and S only
- (3) R and S only
- (4) Q and S only

()

SCORE	2
-------	---

- 11 Firdaus set up a circuit as shown below. All the bulbs and batteries are in working condition.

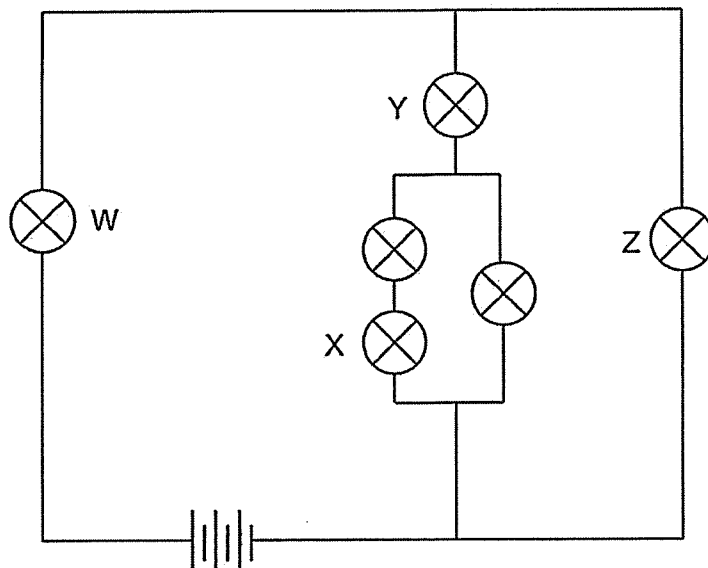

Which of the following **incorrectly** shows the number of bulbs that will still be lit when one of the bulbs is fused?

	Bulb that is fused	Number of bulb(s) still lit
(1)	W	5
(2)	X	4
(3)	Y	2
(4)	Z	5

()

SCORE	2
-------	---

- 12 Ajay conducted an experiment with five objects, A, B, C, D and E. The results of his experiment are shown below.

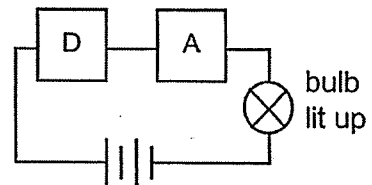
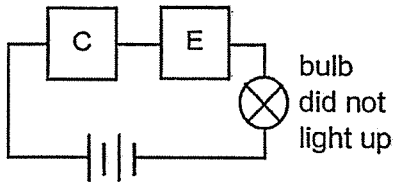
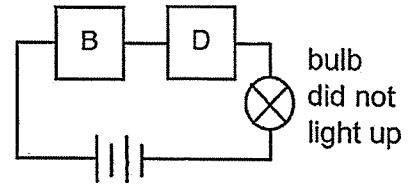
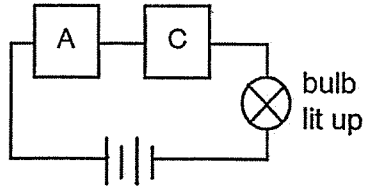

Based on the results of his experiment, which of the following circuits will the bulb **not** light up?

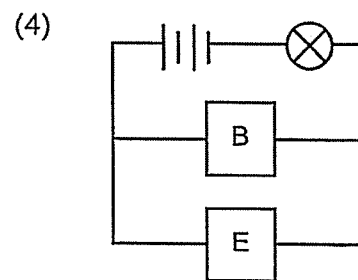
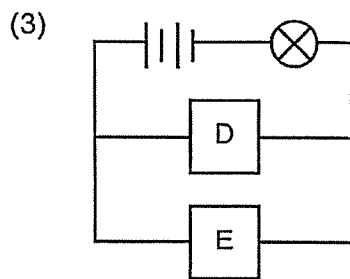
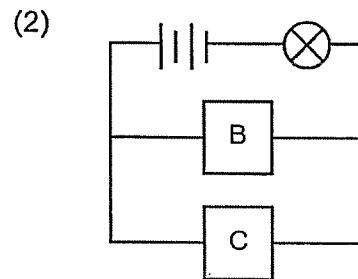
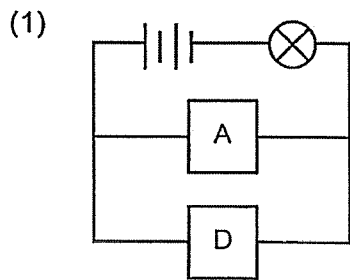

()

SCORE	2
-------	---

Section B: 11 marks

For questions 13 to 15, write your answers in this booklet.

The number of marks available is shown in brackets [] at the end of each question or part question.

- 13 Farmer Tan removed the outer ring of the stem of a flowering plant as shown in the diagram below. In doing so, the food-carrying tubes were removed but the water-carrying tubes were left intact.

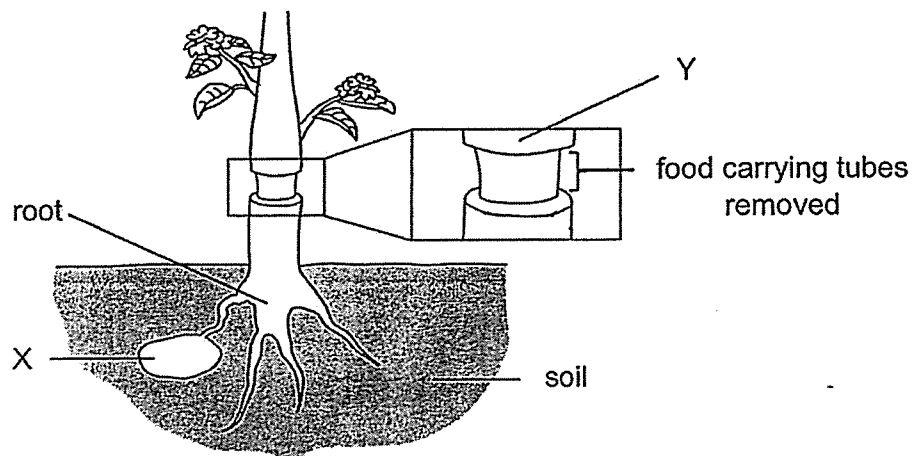

Part X of the plant is where it stores excess food.

- (a) State the function of the food-carrying tubes. [1]

- (b) After a few days, Farmer Tan observed that part Y of the stem started to swell. Explain why. [2]

- (c) Explain why part X became smaller after two weeks. [1]

SCORE	/
	4

- 14 Alicia has a food warmer that uses three lamps to keep food warm. The brighter the lamps, the more heat is given out.

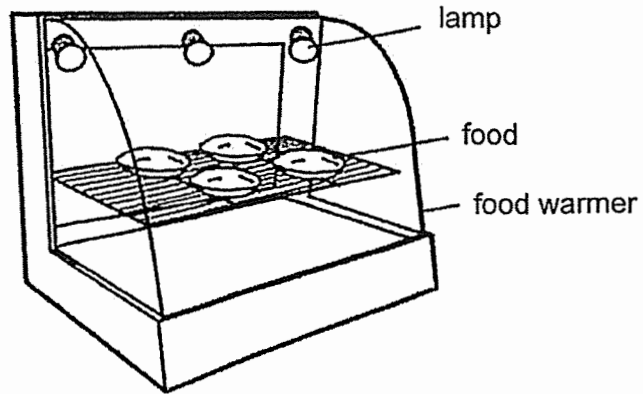

- (a) Use a pencil to complete the circuit below such that all the bulbs of the lamps give out the most amount of heat and when one bulb fused, the other bulbs continue to light up. [1]

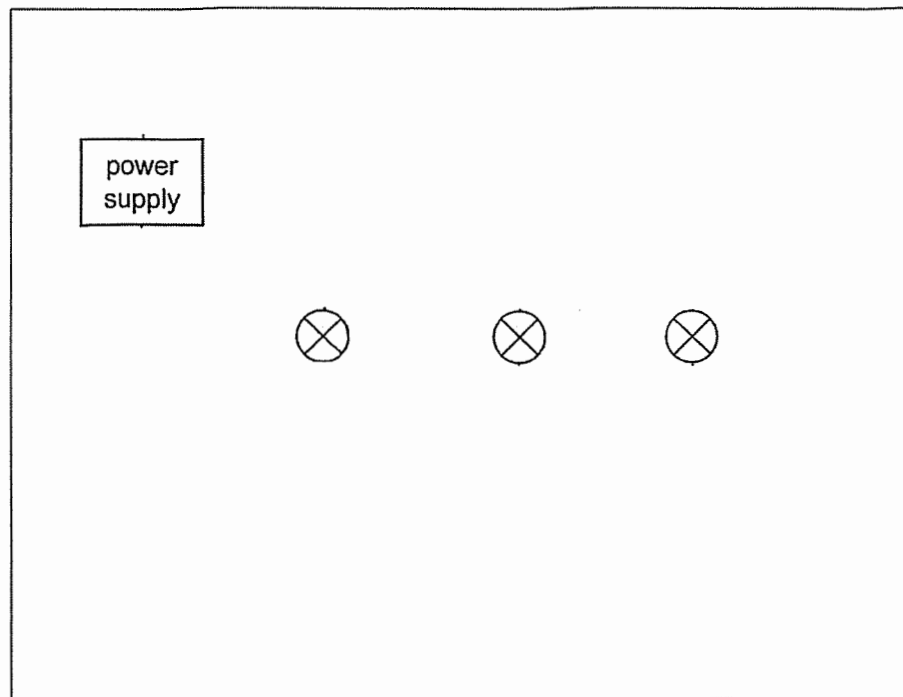

(continues on next page)

SCORE	J 1
-------	--------

ST. HILDA'S PRIMARY SCHOOL
 PRIMARY 5
 TERM 3 WEIGHTED ASSESSMENT, 2025
 SCIENCE

Simplified Answer Key

Section A

1.	2	2.	2	3.	4	4.	3
5.	3	6.	4	7.	1	8.	2
9.	4	10.	2	11.	1	12.	4

Section B

This answer key only provides a reference, and the key concepts have been bolded / underlined. Variations of students' answers have been accepted if they have shown conceptual understanding.

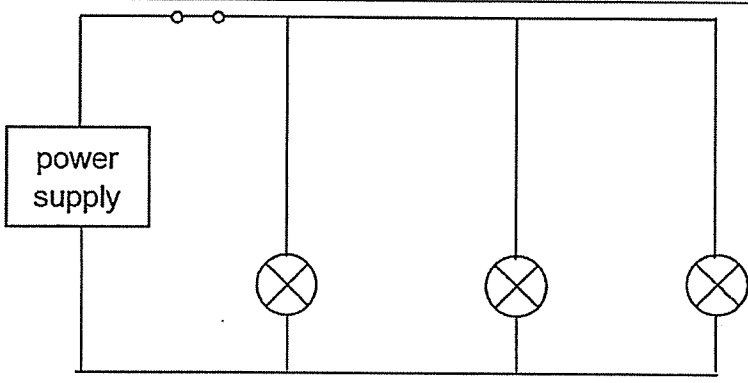
13 (a)	To <u>transport food made in the leaves</u> to <u>all parts of the plant</u> .
(b)	As the food-carrying tubes are removed, food made in the leaves above part Y / above the cut part <u>cannot be transported to below the cut part / part Y</u> so <u>more / excess food</u> is <u>stuck / accumulated</u> at part Y causing it to swell.
(c)	The <u>roots cannot receive food</u> from the leaves <u>so the roots used up the food stored in part X</u> .
14 (a)	

(b)(i)	Bulb P: Light up Bulb Q: Did not light up
(b)(ii)	The brightness of bulb Q remains unchanged / same as bulb Q is arranged in parallel to bulb P.
15(a)	Electrical conductor / conductor of electricity
(b)	When a 32 kg baggage is placed on the platform, the contacts will touch each other. Electric current can flow through the closed circuit to ring the bell.
(c)	No. If the bell does not function, the bulb will also not light up as electric current cannot flow through the open circuit to light up the bulb.